



SYMMONS® Identity™

the smart choice™

Identity Trim Series

Identity Trim Series with TA-10 Flow Control Spindle & T-12A Cap Assembly Installation & Operation Instructions

Model Numbers

TRIM ONLY

6700-TRM
Shower Valve Trim

6701-TRM
Shower Trim

6702-TRM
Tub/Shower Trim

6703-TRM
Hand Shower Trim

6705-TRM
Shower/Hand Shower Trim

6706-TRM
Tub/Shower/Hand Shower Trim

TRIM, TA-10, T-12A

6700TRMTC
Shower Valve Trim

6701TRMTC
Shower Trim

6702TRMTC
Tub/Shower Trim

6703TRMTC
Hand Shower Trim

6705TRMTC
Shower/Hand Shower Trim

6706TRMTC
Tub/Shower/Hand Shower Trim

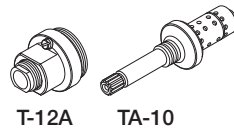

T-12A

TA-10



6700-TRM
6700TRMTC



6701-TRM
6701TRMTC



6702-TRM
6702TRMTC

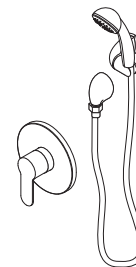

6703-TRM
6703TRMTC

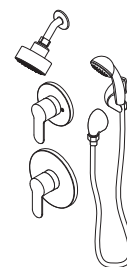

6705-TRM
6705TRMTC

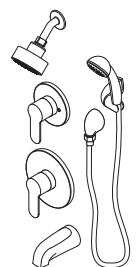

6706-TRM
6706TRMTC

Compliance

- ASME A112.18.1/CSA B125.1



Warranty

Limited Lifetime - to the original end purchaser in consumer/residential installations.

5 Years - for industrial/commercial installations.

Refer to www.symmons.com/warranty for complete warranty information.

Go to www.symmons.com/register to register your Symmons product.

1. Recommended Tools

FIGURE 1

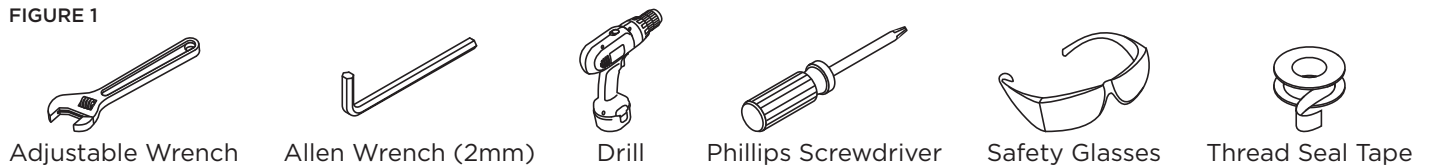

2. Dimensions

FIGURE 2

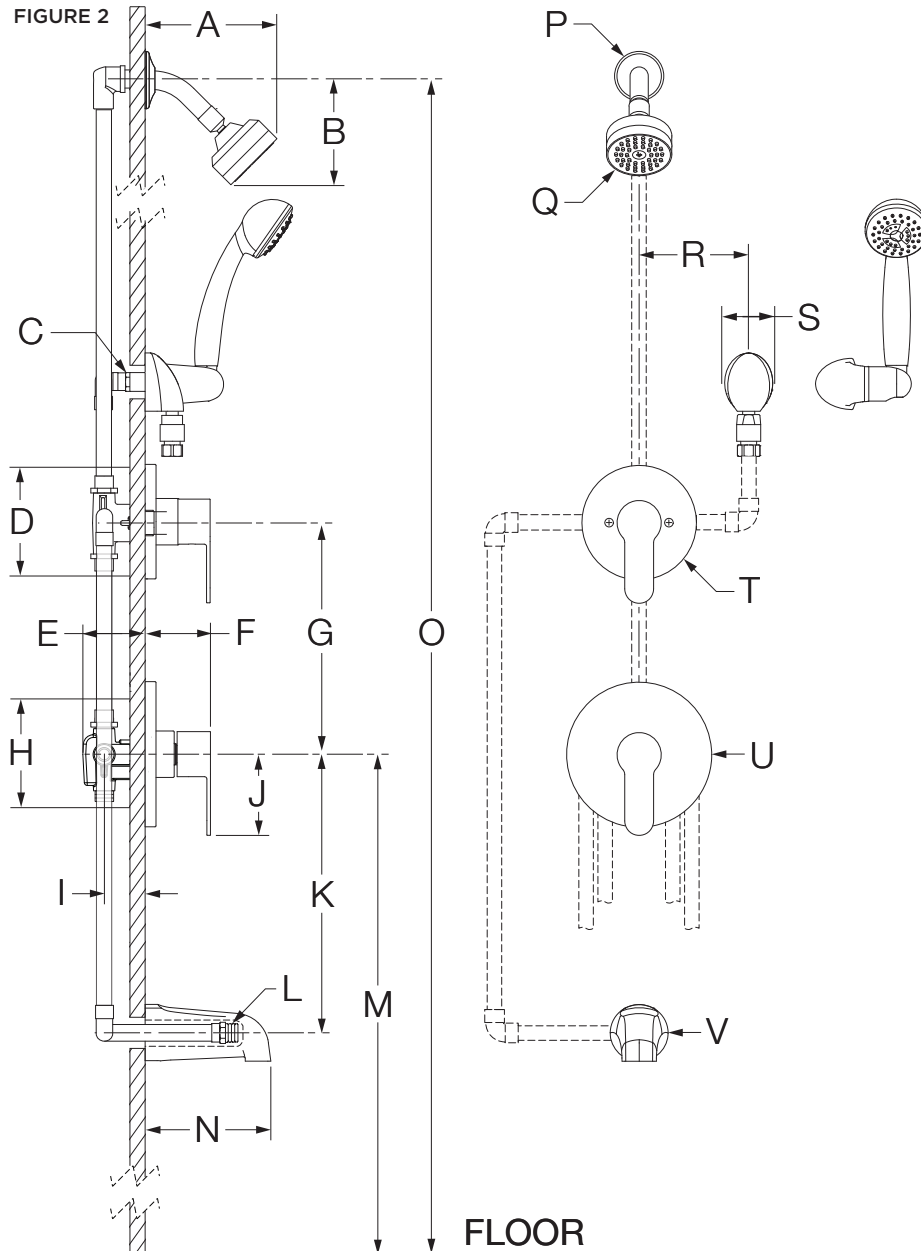

Measurements	
A	5-7/8", 149 mm
B	4-5/8", 117 mm
C	Male 1/2" NPT fitting must be recessed 1/4" (6 mm) from finished wall
D	Diverter Valve Hole Size Min. Ø 3", 76 mm Max. Ø 3-1/4", 83 mm
E	3-5/8", 92 mm
F	2-7/8", 73 mm
G	Ref. 10", 254 mm
H	Shower Valve Hole Size Min. Ø 3", 76 mm Max. Ø 4", 102 mm
I	Rough-in 2-3/8" ± 1/2", 60 mm ± 13 mm
J	3-1/2", 89 mm
K	12", 305 mm
L	Male 1/2" NPT fitting must protrude 4" (102 mm) from finished wall
M	6700, 6701, 6703, 6705: Ref. 42", 1067 mm 6702, 6706: Ref. 32", 813 mm
N	5-1/2", 140 mm
O	Ref. 77", 1956 mm
P	Ø 2-1/2", 64 mm
Q	Ø 3-1/8", 79 mm
R	6", 152 mm
S	2-1/8", 54 mm
T	Ø 5", 127 mm
U	Ø 6-3/8", 162 mm
V	Ø 2-1/2", 64 mm

Notes:

- 1) Valve body and piping not included and shown as reference only.
- 2) Plaster shield (p/n T-176) for dry wall, plaster or other type walls 1/2" or greater.
- 3) All dimensions measured from nominal rough-in (see I as reference).
- 4) Dimensions subject to change without notice.

3. Parts Breakdown (Model Numbers Ending in TRMTC)

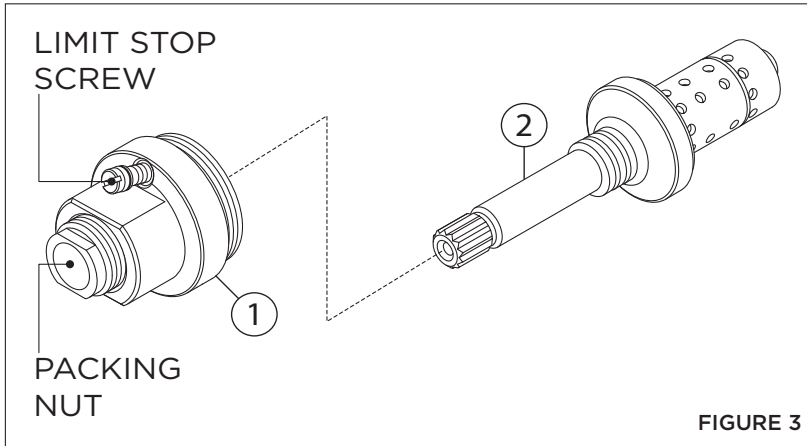

FIGURE 3

Replacement Parts		
Item	Description	Part Number
1	Cap Assy.	T-12A
2	Flow Control Spindle	TA-10

IMPORTANT: Model numbers ending in **TRMTC** coordinate with Temptrol pressure balancing valves ordered with Test Cap. The Test Cap is used to allow pressurization of system. **Do not** remove test cap from valve during wall construction, installation of valve or pressurization of system.

⚠ WARNINGS:

1. Do not expose valve with test cap to heat for longer than 2 minutes when soldering copper tubing. Doing so may damage the internal components of the valve and will void the product warranty.
2. Ensure test cap is **tightened securely** after soldering valve body.

4. Installation - Remove Test Cap (Model Numbers Ending in TRMTC)

Flow control spindle (TA-10) and cap assembly (T-12A) will come factory assembled for all model numbers ending in **TRMTC**. When ready to remove Test Cap and install trim, follow the instructions below:

- 1) Check for leaks around the valve assembly and all pipe fittings.
- 2) Remove test cap from valve (FIGURE 4.1).
- 3) If system is dirty, flush valve.
- 4) Thread flow control spindle and cap assembly into valve body. Turn clockwise to secure to valve (FIGURE 4.2).

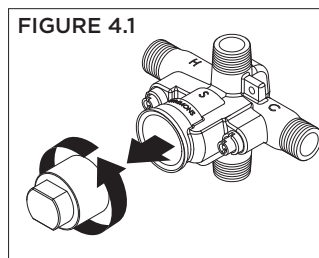

FIGURE 4.1

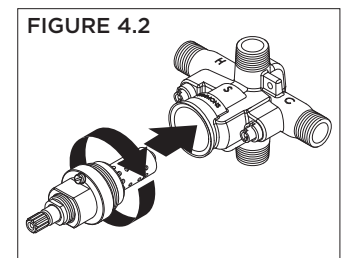

FIGURE 4.2

5. Installation - Adjust Packing Nut (Model Numbers Ending in TRMTC)

- 1) Turn hot and cold supplies on. Valve will not operate unless both hot and cold water supply pressures are on.
- 2) Place handle over flow control spindle.
- 3) Tighten packing nut for positive frictional resistance as handle is rotated from shut-off position across adjustment range.

6. Installation - Setting Limit Stop Screw (Model Numbers Ending in TRMTC)

The temperature limit stop screw limits valve handle from being turned to maximum position resulting in excessive hot water discharge temperatures.

⚠ WARNING: Failure to adjust limit stop screw properly may result in serious scalding.

- 1) Turn hot and cold supplies on. Valve will not operate unless both hot and cold water supply pressures are on.
- 2) Place handle on flow control spindle and open valve to maximum desired temperature.
- 3) Turn limit stop screw clockwise until it seats.

7. Parts Breakdown

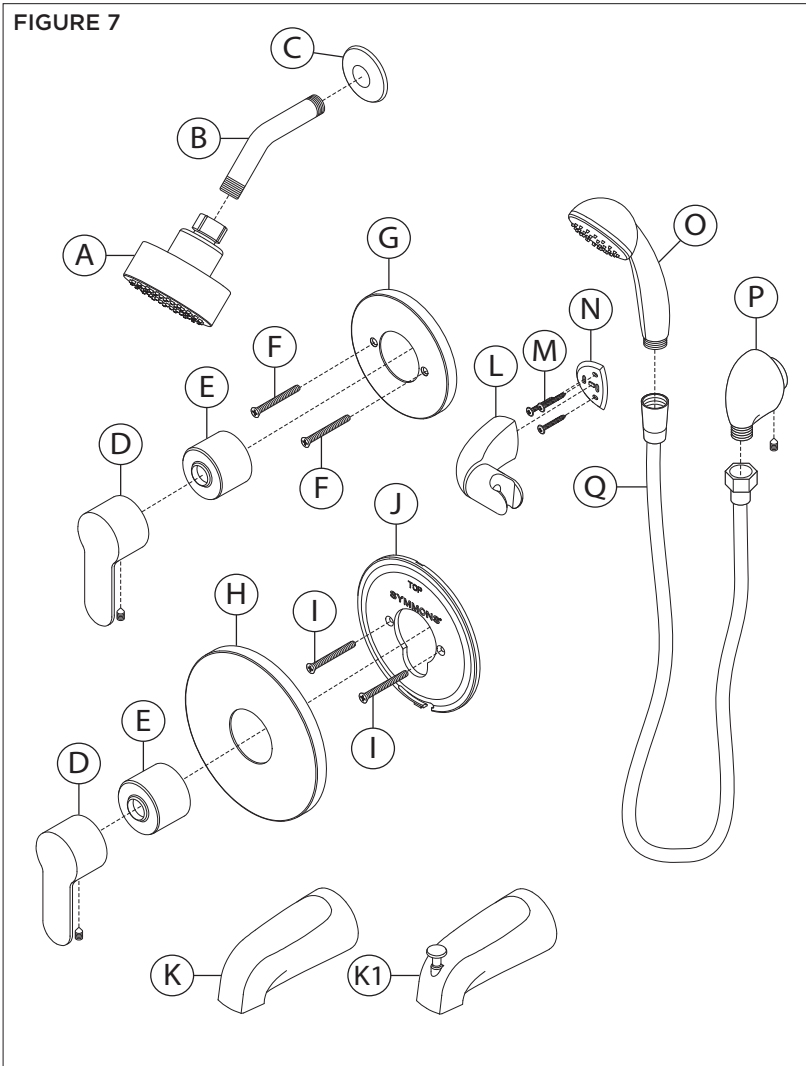

Replacement Parts		
Item	Description	Part Number
A	Showerhead	672SH
B	Shower Arm	
C	Flange	300S
D	Handle Assy.	RTS-084
E	Dome Cover	T-19
F	Diverter Escutcheon	
G	Screws	67-DIV-ESC
H	Shower Escutcheon	
I	Screws	6700-ESC
J	Mounting Plate	
K	Tub Spout	060
K1	Diverter Tub Spout	054
L	Wall Cradle	
M	Screws	EF-106
N	Mounting Plate	
O	Hand Shower	EF-100
P	Wall Elbow	EF-105
Q	60" Hose	RTS-045

Notes:

- 1) Append appropriate suffix for premium finish.
- 2) Append appropriate flow rate to showerhead or hand shower for low flow.
- 3) Apply a bead of silicone around the perimeter of all shower trim installed flush to the finished wall. Leave opening on bottom of escutcheons for weep hole.
- 4) Apply plumber tape to all threaded connections.



*Order in-line vacuum breaker (EF-109) for hand shower systems without dual checks.

8. Installation - Shower Valve Trim

- 1) Secure large mounting plate to Temptrol pressure balancing valve using mounting screws (FIGURE 8.1).
- 2) Secure large shower escutcheon to mounting plate. Tabs should snap in place (FIGURE 8.2).
- 3) Install dome cover by turning clockwise (FIGURE 8.3).
- 4) Install handle to shower valve. Secure with set screw (FIGURE 8.4).

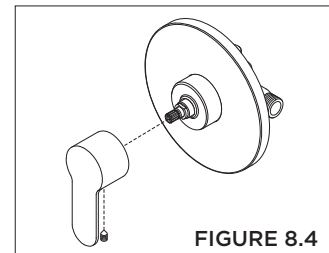
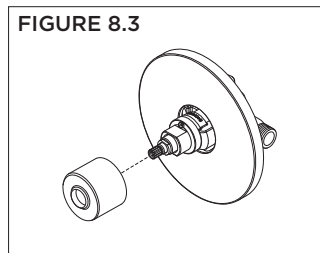
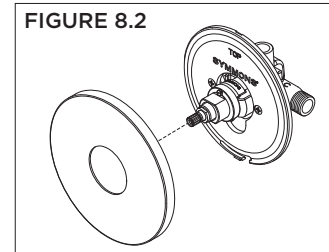
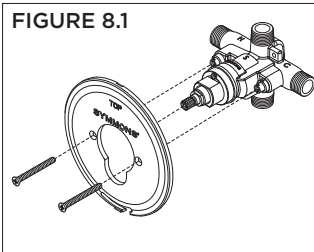

9. Installation - Diverter Valve Trim

- 1) Secure small diverter escutcheon to Symmons diverter valve using mounting screws (FIGURE 9.1).
- 2) Install dome cover by turning clockwise (FIGURE 9.2).
- 3) Install handle to diverter valve. Secure with set screw (FIGURE 9.3).

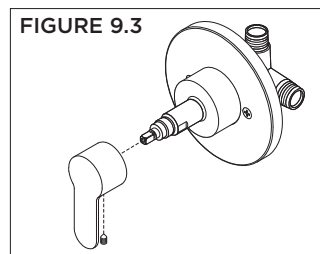
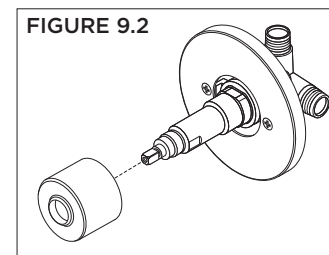
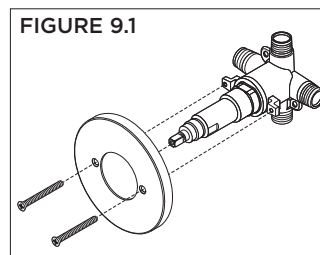

10. Installation - Showerhead & Tub Spout

- 1) Attach arm and flange to shower pipe. Turn clockwise to tighten (FIGURE 10.1).
- 2) Install showerhead to shower arm. Turn clockwise to tighten (FIGURE 10.2).
- 3) Install tub spout to stub out pipe. Turn clockwise to tighten (FIGURE 10.3).

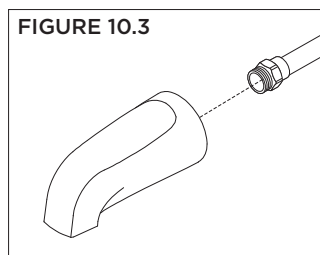
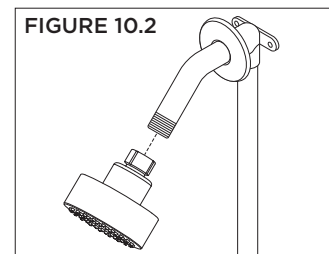
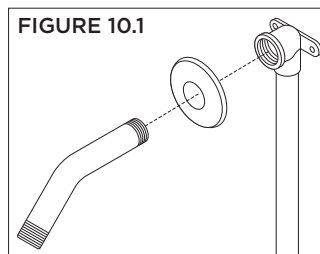

11. Installation - Slide Bar Assembly

1) Place mounting plate in position. Mark and drill $3/16$ " holes for tile anchors, $5/16$ " holes for drywall anchors. Install anchors (FIGURE 11.1).

Note: For dry wall $1/2$ " thick or less, insert anchor tool into drywall anchor to secure behind wall prior to installing wall cradle.

2) Remove cover of hand shower cradle. Install cradle and mounting plate. Secure with three screws. Replace cover on hand shower cradle (FIGURE 11.2).

3) Install wall elbow to stub out pipe. Tighten set screw to secure (FIGURE 11.3).

4) Attach small end of hand shower hose to wall elbow. Turn clockwise to tighten (FIGURE 11.4).

5) Attach large end of hand shower hose to hand shower wand. Turn clockwise to tighten (FIGURE 11.5).

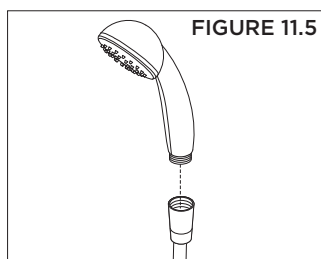
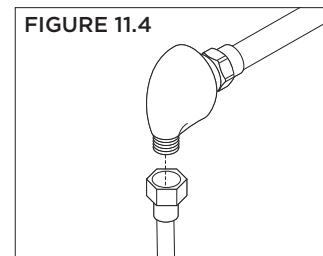
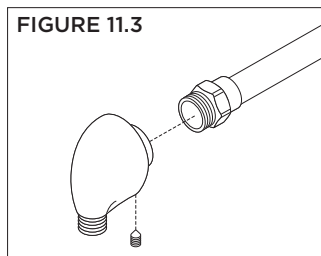
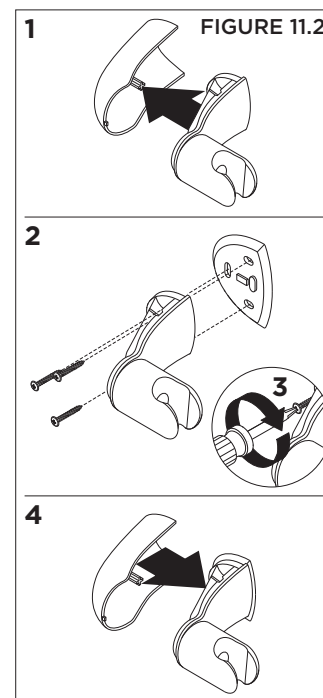
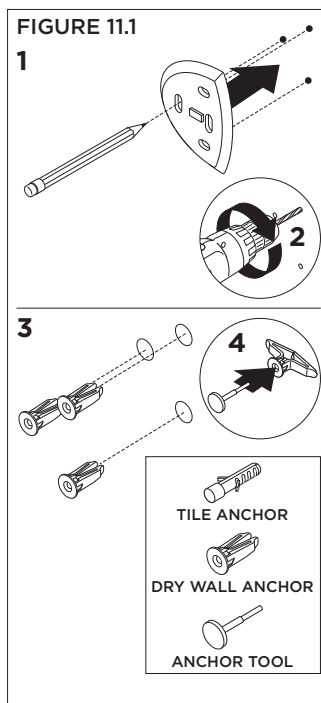

12. Operation (Temperature Control)

- 1) Turn shower handle counter-clockwise approximately 1/4 turn to put valve in cold position (FIGURE 12.1).
- 2) Turn shower handle counter-clockwise approximately 1/2 turn to put valve in warm position (FIGURE 12.2).
- 3) Turn shower handle counter-clockwise approximately 3/4 turn to put valve in hot position (FIGURE 12.3).

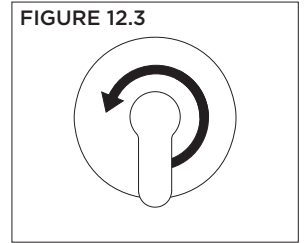
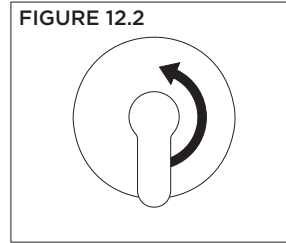
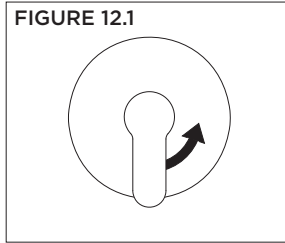

13. Operation (Dual Outlet Diverter Control)

Note: Additional handle positions for same output are illustrated.

- 1) Cartridge is factory set to divert to function 1 (FIGURE 13.1).
- 2) Turn handle to position 2 to divert to function 2 (FIGURE 13.2).
- 3) Turn handle to position 3 to share functions 1 and 2 (FIGURE 13.3).

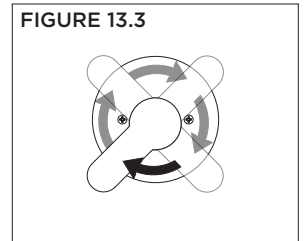
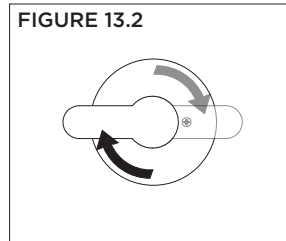
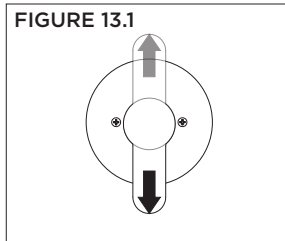

14. Operation (Triple Outlet Diverter Control)

- 1) Cartridge is factory set to divert to function 1 (FIGURE 14.1).
- 2) Turn handle to position 2 to divert to function 2 (FIGURE 14.2).
- 3) Turn handle to position 3 to divert to function 3 (FIGURE 14.3).
- 4) Turn handle to position 4 to share functions 2 and 3 (FIGURE 14.4).
- 5) Turn handle to position 5 to share functions 1 and 3 (FIGURE 14.5).
- 6) Turn handle to position 6 to share functions 1 and 2 (FIGURE 14.6).

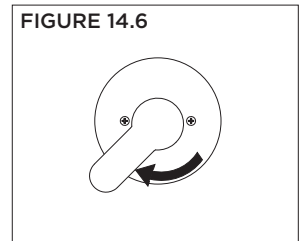
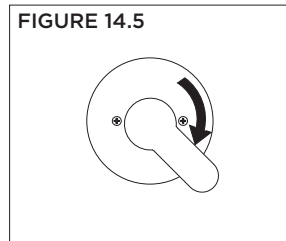
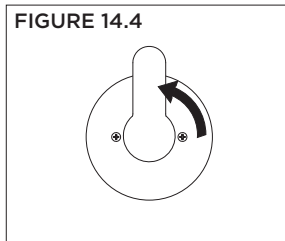
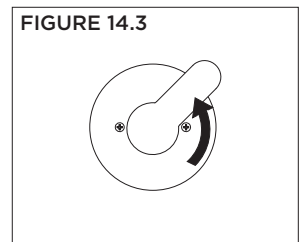
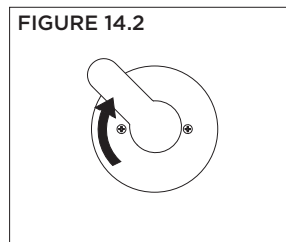
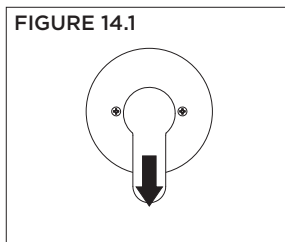

15. Troubleshooting Chart

Problem	Cause	Solution
Finish is spotting.	Elements in water supply may cause water staining on finish.	Clean finished trim area with a soft cloth using mild soap and water or a non-abrasive cleaner and then quickly rinse with water.

 **WARNING:** This product can expose you to chemicals including lead, which is known to the state of California to cause cancer, birth defects, or other reproductive harm. For more information, go to www.P65Warnings.ca.gov.